

T-Series

# The simple solution



**EPSON®**  
EXCEED YOUR VISION

# Ideal for pick-and-place applications

Intelligent, efficient and cost-effective, the comprehensive T-Series range is designed to make simple pick-and-place applications run more smoothly.

These 4-axis robots are the ideal automation solution where linear systems are used.

## Introducing the new T6

The new T6 can transport larger, heavier objects using a 6kg payload capacity – double that of the T3 robot. The T6 can be equipped with heavy end-effectors, such as dual end-effectors for holding two objects at once, to help manufacturers increase factory productivity.

## Power at an affordable price

The Epson T-Series offers an excellent price/performance ratio. You have a choice of diverse connection options, including Profibus and Profinet. The T-Series range also supports image processing and integrates with external software. You can even design your own user interface to run on the robots.

The Epson T6 and T3 are available to order at [www.epson.eu/store](http://www.epson.eu/store)

## Benefits of the T-Series at a glance

**Flexibility:** the 4-axis robot provides a great range of motion

**Intelligence:** powerful, integrated controller and system connection

**Efficiency:** simple cabling for easy operation and maintenance

**Energy-saving:** low power consumption

**Space-saving:** very small footprint, which includes the controller

**Sustainability:** battery-free position sensor



**T3-401S**

Range: 400 mm  
Load capacity: 3 kg



**T6-602S**

Range: 600 mm  
Load capacity: 6 kg

# A class above manual operation and linear axes

## Typical applications for the Epson T-Series include:

Pick-and-place applications performed manually, or via linear axes, with a repeatability of 0.02 mm

Part feeding, positioning and inspection tasks

Assembly tasks, including those supported by the Epson Vision System

Material coating at moderate speed

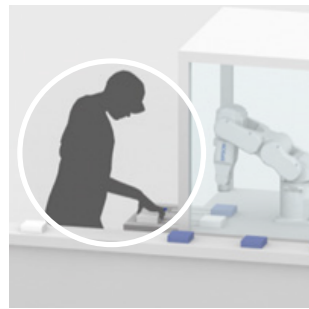

Inefficient manual pick-and-place applications



Easy-to-use T series automation



High complexity in applications with combined linear axes



## Performance improvements compared with manual operation:

- More stable, continuous work processes
- Reduced error rate
- Seamless traceability in digitised processes
- Shorter throughput times

## Performance improvements compared with linear axes:

- Lower running costs
- Significantly lower space requirements
- Simpler cabling
- Lower maintenance costs
- Increased flexibility
- Less unplanned machine downtime
- No restriction on single-purpose usage
- Connections for end effectors

# Impressive performance

The T-Series features fully developed SCARA robots, which can be combined with a range of tools. The robots include six inputs and four outputs for end effectors.

An integrated controller not only saves space, but also greatly simplifies installation, commissioning and later replacement of the robot.

Internal power supply cables built into every Epson robot system ensure it is reliable and quick to commission.

## Cut energy consumption by 30%

Power consumption on the T-Series robots is up to 30% lower than conventional SCARA robots. The environmentally friendly battery-less motor unit in the T-Series further reduces operating costs.

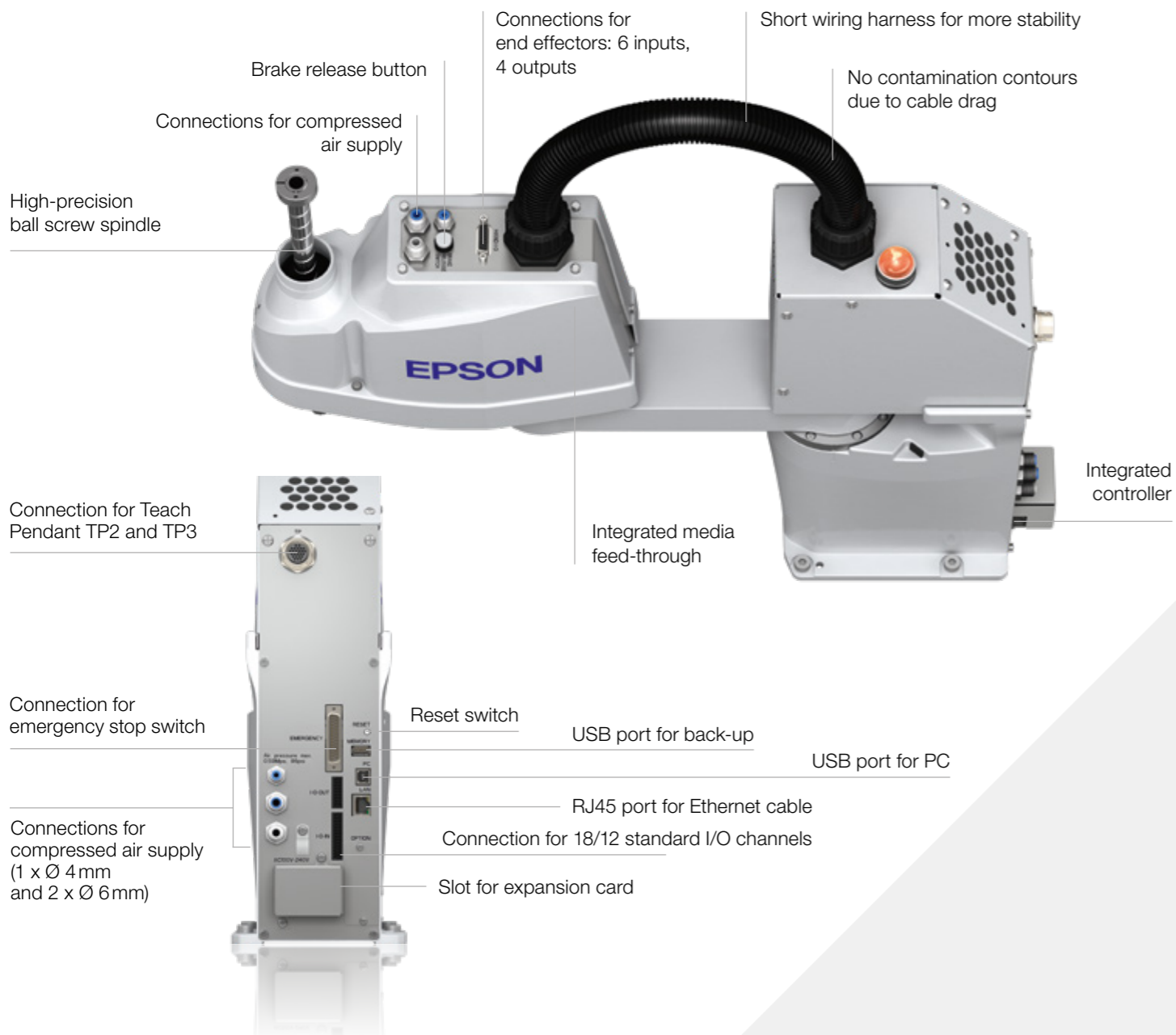

# The perfect fit for your production line

RC+ development environment

Factory controller

e.g. industry PC

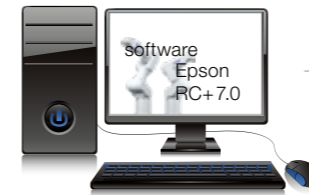

Epson SCARA T3-401S

Image processing

Extension Fieldbus Cards

Teaching pendant



CV1/CV2



TP2

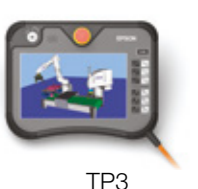

TP3

## The T-Series supports all these software options:

**Vision Guide 7.0** Epson image processing software with support for high-resolution cameras and colour cameras

**RC+ API 7.0** For convenient integration of external software and databases and the development of custom user-interfaces

**External control point (ECP)** For easy teaching of corners and curves

**GUI Builder 7.0** For designing your own user interface based on the simple Epson programming language SPEL+

**Optical character recognition (OCR)** For safe detection and control of fonts and symbols



# Technical specifications

## SCARA T6-602S

Design	Outwardly oriented horizontal articulated arm
Load capacity	2/6 kg
Horizontal range	600 mm
Vertical range	200 mm
Arm length	J1 325 mm + J2 275 mm
Orientation range	J4 +/- 360 °
Horizontal repeatability	J1, J2 +/- 0.04 mm
Vertical repeatability	J3 +/- 0.02 mm
Orientation repeatability	J4 +/- 0.02 °
Max. working range	J1 +/- 132 °, J2 +/- 150 ° J3 200 mm, J4 +/- 360 °
Max. axial speed	J1, J2 4180 mm /s J3 1,000 mm /s, J4 1800 °/s
Mass moment of inertia	0.01 / 0.08 kg.m <sup>2</sup>
Permanent press-in force	83 N
Installation type	Floor
Z-axis outside / inside	20 H7 / 14 mm
Power ratings / cable length	AC 100 V to AC 240 V / 5 m
Certification	CE Mark, EMC Directive, Machinery Directive, RoHS Directive, ANSI / RIA R15.06 – 2012 NFPA 79 (2007 Edition)
Weight	22 kg

J1 = Axis 1      J2 = Axis 2      J3 = Axis 3      J4 = Axis 4

### Package:

- Epson robot with integrated controller
- 1 Epson RC+ program DVD including simulator
- 1 plug for emergency stop
- 1 plug for standard I/O
- 1 USB programming cable
- Manuals on CD
- 1 installation / safety manual
- 1 TP/bypass plug (pre-installed at factory)

### Available options:

- Fieldbus slave card:  
CC-LINK, Profibus, Profinet, Devicenet, Ethernet I/P,  
EtherCat
- Fieldbus master card (requires external PC):  
Profibus, Devicenet, Ethernet I/P

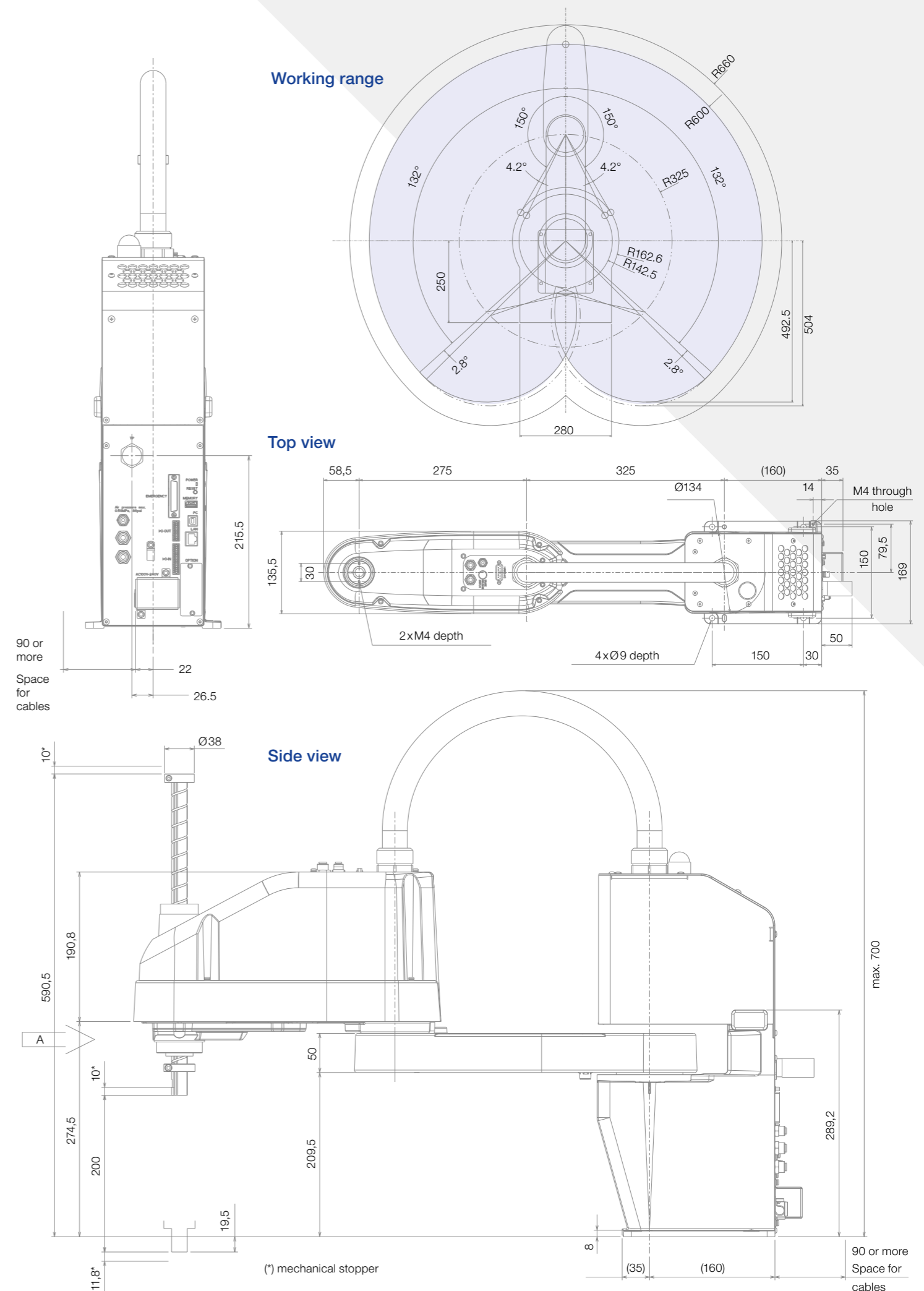

# Maximise your production line efficiency

Epson robot systems: precise, fast and reliable

Epson offers one of the world's most extensive SCARA model ranges, including 6-axis robots, controllers and software.

Our products work together with precision, even at breathtaking speeds and often for up to 24 hours a day.



## Epson Spider Robots

A unique design means the Epson Spider robot reaches every corner of its workspace to achieve unmatched cycle times.



## Epson Scara Robots

Compact and powerful Epson SCARA robots work with total precision even at high speeds. We offer the world's largest range of SCARA robots, with over 400 variants.

# Total support for your Epson robot systems

We offer a comprehensive pre- and after-sales support programme on all our robot systems, including:

Feasibility studies to maximise planning and project security

Support to improve planning and implementation

Introductory seminars, programming/maintenance courses, operator training

Inspection and individual maintenance ideas

Hotline and on-site repair service

Central spare part stocking



## Epson Controllers

Robust, space saving integrated controllers manage both manipulators and peripherals.



## Epson 6-Axis Robot

Extra flexibility from rotating axes offer unrivalled point-and-track accuracy, so complex work processes can be executed precisely.

# Simulation of robot cells

Good preparation is everything. Plan and visualise all procedures in your production, validate your program offline initially and carry out troubleshooting and editing work easily from your desk. With the Epson RC+ Simulator – included in the software package – you save time and money through all phases of your project.

## Phase 1 Design

Plan your robot cell at full size in advance and work out the expected cycle time for your application to check feasibility before a single part for the system has been made. Plan future system expansions in the simulation system to keep downtime to a minimum.

## Phase 2 Integration

Completing the program validation process before the robots are delivered enables you to create programs at the same time, with the system capable of displaying and evaluating even complex motions. Collision risks are identified and equipment damage is prevented.

## Phase 3 Operation and maintenance

Troubleshoot and modify programs from your desk. Use the 3D layout to visualise collision detection, reachability checks and robot motions.

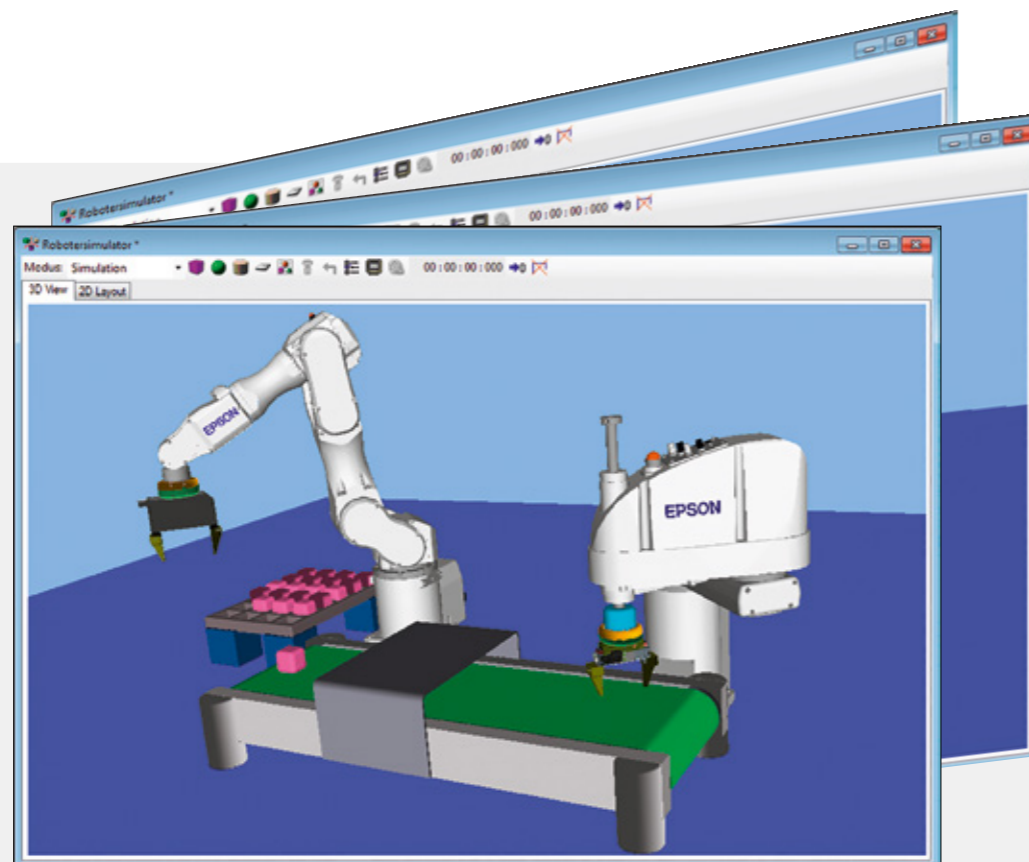
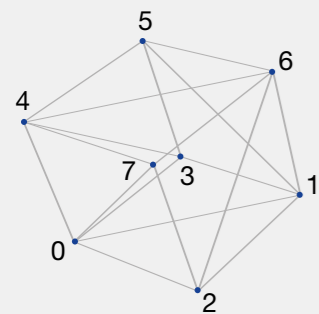

# About Epson

Epson Robotic Solutions is one of the leading suppliers of high tech robot systems that are renowned worldwide for their reliability. The product range includes six-axis robots, SCARA robots, the SCARA entry-level LS and T models, the special Epson-developed Spider and N robots types, as well as the pioneering Dual Arm robot. Added to this are image processing controls and the Epson Force Sensor for force-controlled applications.

This gives Epson Robotic Solutions one of the most comprehensive ranges of high-precision industrial robots in the world, making them a technological pioneer for intelligently controlled automation processes.

## Technological pioneer

### 1982

Epson SCARA robots freely available in Japan for the first time

### 1986

First cleanroom robot class 1

### 1997

First PC-based controller

### 2008

Inventor of the right or left arm-optimised G3 SCARA robot

### 2009

Inventor of the spider – a unique SCARA robot with no dead zones

### 2013

First application of Epson QMEMS® sensors in robotics, reducing six-axis kinematics vibrations

### 2014

Epson Compact Vision CV2: Epson's own ultra-fast image processing computer

### 2016

Epson N2 series: World's first 6-axis robot with folding arm – extremely compact and space-saving

### 2017

Epson Dual Arm robot with an arm geometry inspired by human physiology, as well as integrated sensors such as cameras, force sensors, and accelerometers

## Pre and after-sales support

Feasibility studies for maximum planning and project security

Support for planning and implementation

Introductory seminars, programming/maintenance courses, operator training

Inspection and individual maintenance concepts

Hotline service, on-site repair service

Central spare part stocking



# Epson Industrial Solutions Center – find your solution



Experience all our Epson robots in action. Build, simulate and improve your automation application in a workshop cell, with help from our experts. The cell can be controlled and networked using all conventional fieldbus systems. In addition, we can supply you with modern peripherals such as a vision and conveyor tracking system.

## Make an appointment

Call us on  
**+49 2159 5381800**

or send an email to  
**info.rs@epson.de**

Epson Deutschland GmbH  
Robotic Solutions  
Otto-Hahn-Strasse 4  
40670 Meerbusch

Phone: **+49 2159 5381800**  
Fax: **+49 2159 5383170**  
E-mail: **info.rs@epson.de**  
**www.epson.de/robots**

Epson America Inc.  
[www.epsonrobots.com](http://www.epsonrobots.com)

Seiko Epson Corp  
<http://global.epson.com/products/robots/>

Epson China Co, Ltd.  
[www.epson.com.cn/robots/](http://www.epson.com.cn/robots/)

For further information please contact your local Epson office or visit [www.epson-europe.com](http://www.epson-europe.com)

Algeria (+2213) 770 938 617 Austria 01 253 49 78 333 Belgium +32 (0)2 792 04 47 Czech 800/142 052 Denmark 44 50 85 85 East Africa (+254) 734 354 075  
Finland 0201 552 091 France 09 74 75 04 04 (Cost of local call, operator charges may apply) Germany +49 (0) 2159/92 79 500 Greece (0030) 211 198 62 12  
Hungary 06800 147 83 Ireland 01 436 7742 Israel (+972)-3-5751833 Italy 02-660321 10 (0,12 €/min) Luxembourg +352 27860692 Middle East +9714 2677638  
Morocco (+212) 661 31 11 18 Netherlands +31 (0)20 708 5099 Norway +47 67 11 37 00 Poland 0-0-800 4911299 (0,16 zł/min) Portugal 707 222 111  
Russia (095) 777-03-55 Slovakia 0850 111 429 Southern Africa (+2711) 465-9621 Spain 93 582 15 00 Sweden 0771-400135 (Mobilsamtal – 0,99 kr/min,  
Lokala samtal – 0,30 kr/min, Utlandssamtal – 0,89 kr/min) Switzerland 022 592 7923 Tunisia (+216) 9833 3571 Turkey (0212) 3360303  
United Kingdom 0871 222 6702 West Africa (+234)8020727843

Trademarks and registered trademarks are the property of Seiko Epson Corporation or their respective owners.  
Product information is subject to change without prior notice.

**EPSON**®